

MAK EURO BLOCK

YOUR SMART USE

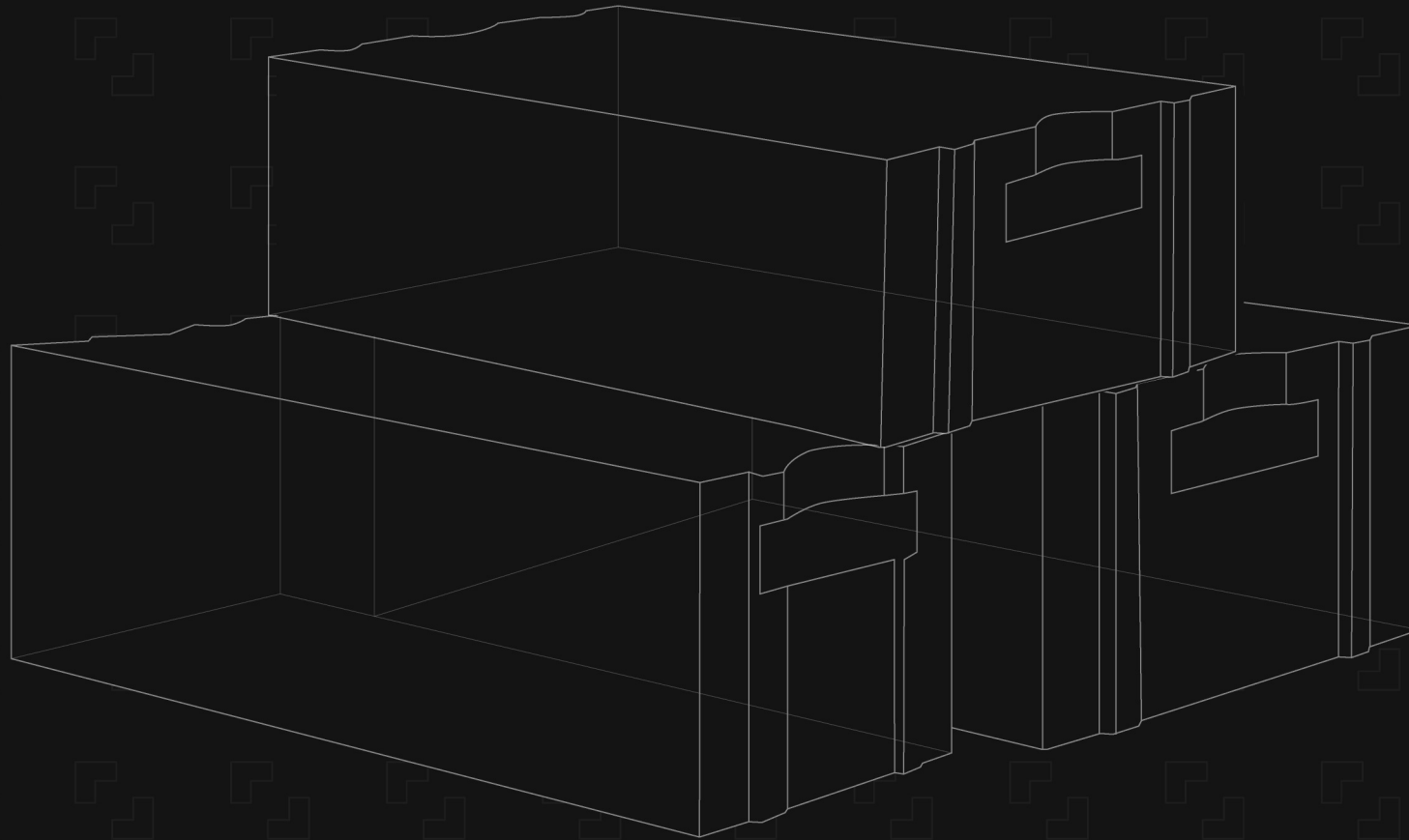

“MAK Euro Block” Plant

MAK Euro Block Plant has successfully implemented cutting-edge technology, advanced methods, and fully automated equipment provided by HESS AAC Systems, a proud member of the prestigious German TOP-WERK Group. Since 2015, MAK Euro Block Plant has been dedicated to manufacturing and supplying EU-standard autoclaved aerated concrete blocks, proudly branded as MAK Euro Blocks, to the market.



The highest award for
the national development
“STATE GEREGE”



No water waste, water consumption

50% LESS

Plant conveyer is

FULLY AUTOMATED

Total capacity of the plant

336,000 M³ PER ANNUM



Total area of the plant: **18,500 M²**

Highlight numbers



40% LESS

Cost per cubic meter

Increase productivity by

4 TIMES



Implemented quality requirements of



13

STANDARDS



9

competitive properties
of the product

9

ranges of
dimensions



Ingredients

The Euro Block is composed of a mix of quartz sand, lime, cement, gypsum, and water, resulting in a product that contains 60% to 85% air pockets within its volume.

Euro Block ingredients:



Quartz sand



Cement



Lime



Gypsum

Product lines

Autoclaved Aerated Concrete (AAC) was originally developed in Sweden in 1924 and has since gained widespread popularity in Europe as one of the most commonly used building materials. Its usage has also been increasing in numerous other countries worldwide. The MAK Euro Block, made of autoclaved aerated concrete, is widely employed in various construction projects, including residential, commercial, and industrial buildings. Notable for its lightweight nature, the MAK Euro Block is also known for its exceptional strength, high load-bearing capacity, and long-lasting durability, making it an excellent choice for construction purposes.



Euro Block

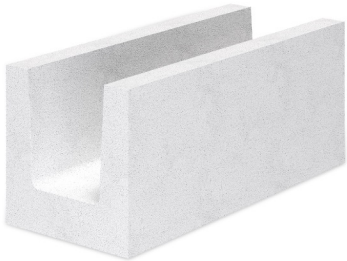

U block



Insulation material

Physical and technical characteristics	Unit of measures	Euro Block			
Density	-	D400	D500	D600	D700
Firmness	-	B2.0	B2.5	B3.5	B5.0
Heat transfer coefficient under dry condition	Bt/m ² c	0.09	0.11	0.13	0.18
Cold tolerance	Cycle	F35	F35	F50	F50
Fire resistance	Hour	>4 hours			
Drying shrinkage	mm/m	<0.24			

Euro Block

MAK Euro Block is manufactured in sizes of 600 x 250mm in length and height, and 100-500mm in width.

Density (kg/m ³)	D400, D500, D600, D700									
Length (mm)	600									
Height (mm)	250									
Width (mm)	100	125	150	200	250	300	375	400	500	
Vertical groove	-	-	-	+	+	+	+	+	+	
Carry handle	-	-	-	+	+	+	+	+	+	
Packaging (m ³)	1.8	1.8	1.8	1.68	1.8	1.8	1.8	1.92	1.8	
Number of blocks on a wooden platform	120	96	80	56	48	40	32	32	24	
Number of square meters build by per m ³	10	8	6.6	5	4	3.3	2.6	2.5	2	
Number of blocks in a per m ³	66.6	53.3	44.4	33.3	26.6	22.2	17.7	16.7	13.3	

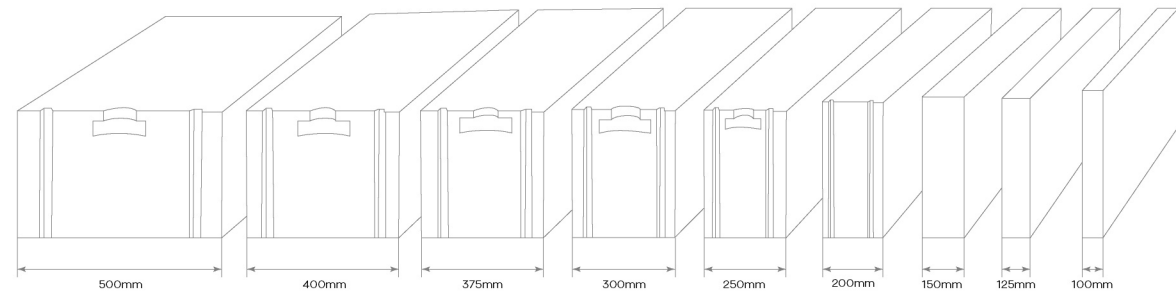
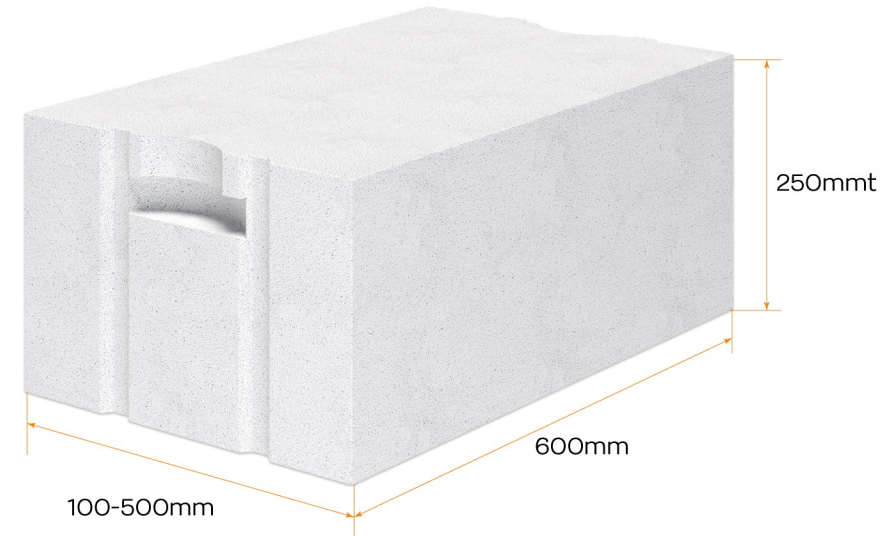

U block

The U Block, a U-shaped AAC material with precise dimensional cutting accuracy, serves multiple purposes in construction. It is commonly utilized as a permanent fence and is ideal for creating door and window lintels, monolithic reinforced concrete structures, rafter columns, prefabricated and floated walls, as well as single and double reinforced concrete slabs. In addition to its versatility, the U Block provides effective protection against the penetration of heat and cold, enhancing thermal insulation within buildings.

Density (kg/m ³)	U block				
Length (mm)	400, 500				
Height (mm)	250				
Width (mm)	250	300	375	400	500

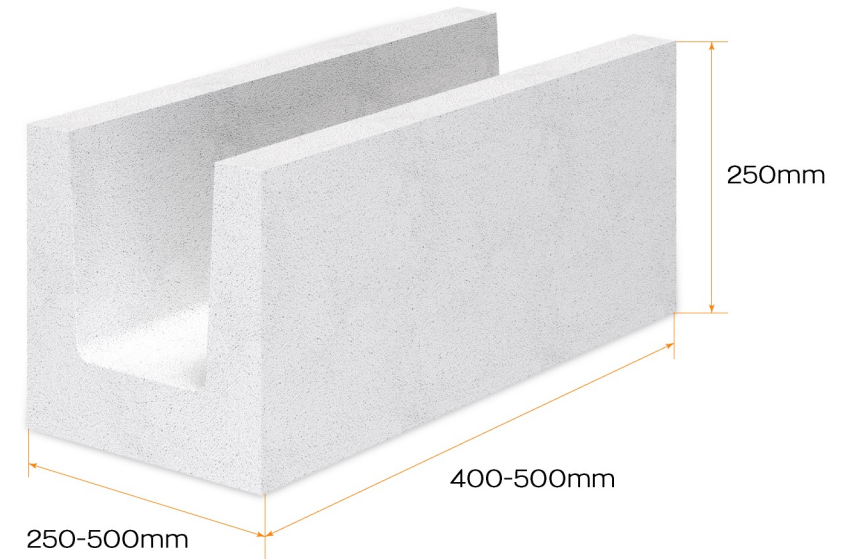
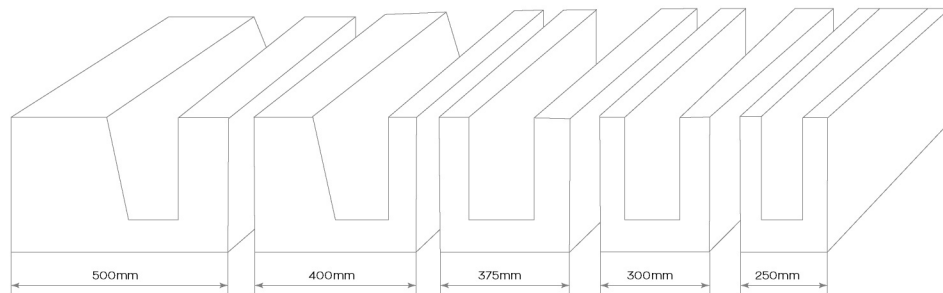

Insulation material

Aerated concrete insulation material possesses a unique structure, providing excellent moisture and heat insulation properties. This remarkable material is non-combustible, resistant to rot caused by chemical reactions, and it has no detrimental effects on human health or the environment. Its ability to "breathe" allows for the permeation of water vapor, which helps stabilize humidity levels within a room, resulting in a healthier and more comfortable living environment. Furthermore, utilizing cast insulation material instead of expanded clay aggregate for roofs and floors offers the added advantage of reducing construction costs.



9 advantages

Significantly enhances productivity by 4 times compared to traditional building materials

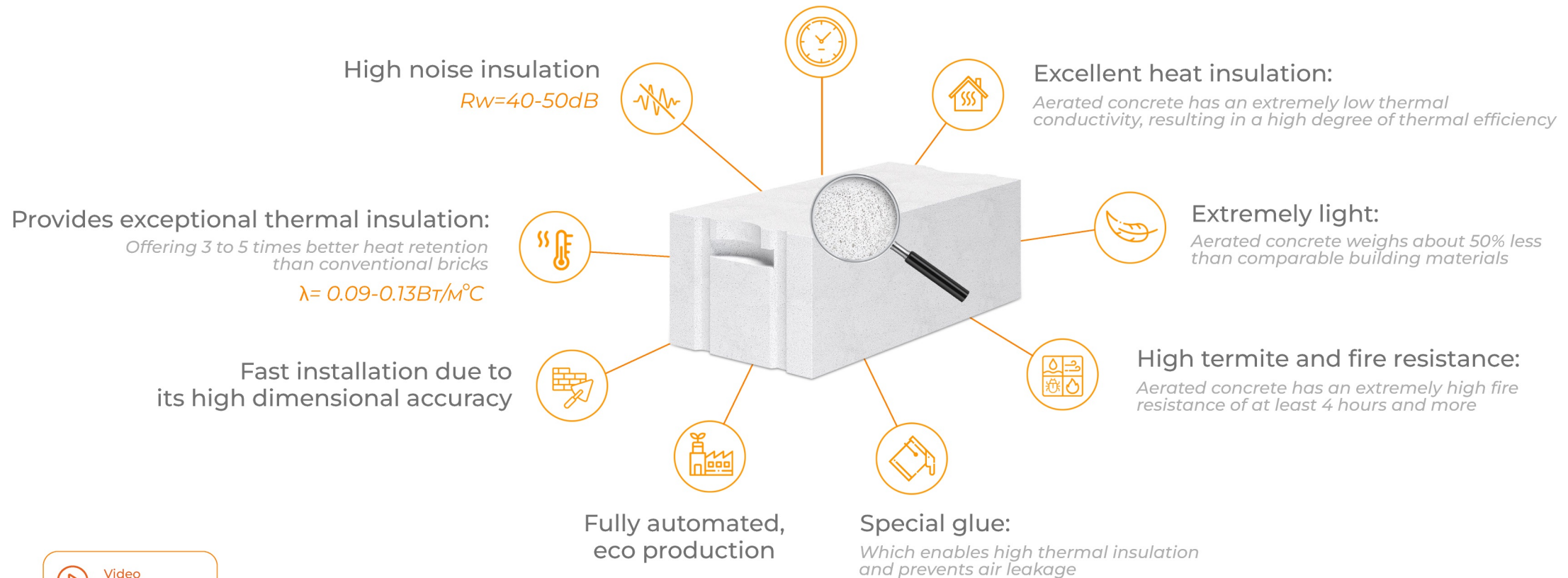

Standards

Since 2015, MAK Euro Block Plant has been the pioneering autoclaved aerated concrete manufacturing facility in Mongolia. We take pride in being the first plant in the country to produce Euro Block that complies with European standards. Among the 10 types of standards that we meet for our products, MAK Euro Block Plant has introduced and obtained national approval for 3 European standards in Mongolia. Additionally, we have implemented 3 international ISO standards, further enhancing the quality and compliance of our offerings.



3 MNS EN

Newly confirmed MNS EN standards
by MAK Euro Block

2 MNS

National standards implemented
by MAK Euro Bloc

5 EN

Euro standards met
by MAK Euro Block

3 ISO

ISO standards introduced
by MAK Euro Block

Social responsibility



In 2017, MAK Euro Block Plant provided valuable assistance by donating 170m³ of Euro Blocks for the construction of the Education and Development Center at Magic Land Mongolia Child Protection and Development Center.



In 2020, MAK Euro Block Plant supplied Euro Blocks for a target project undertaken by Dream House company.



In 2022, MAK Euro Block Plant collaborated with the construction of a secondary school for 960 children in Eruu Soum, Selenge province, providing Euro Blocks as a grant.



In 2023, MAK Euro Block Plant partnered with Mood Union on the "Shinechilgee" project, supplying Euro Blocks and offering their cooperation.

Clients

1000+

Clients



Featured projects:



Featured clients:



Procurement process

Order through MAKBM app

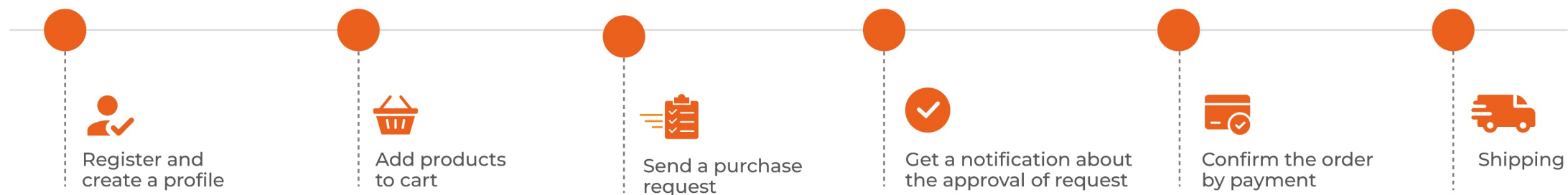

Order by phone

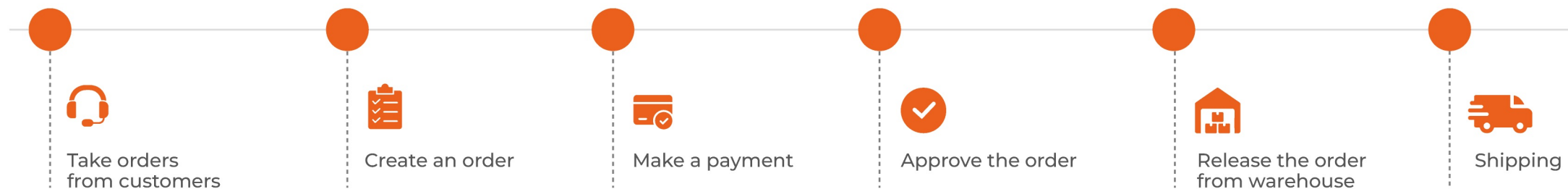

"MAK Euro Block" plant address

Sergelen Soum, Tuv Province 47 km from Ulaanbaatar



"MAK EAST" building materials store

South east of central railway repair station



"MAK WEST" building materials store

Along the bureau 22 road, 2 km from Sansar supermarket

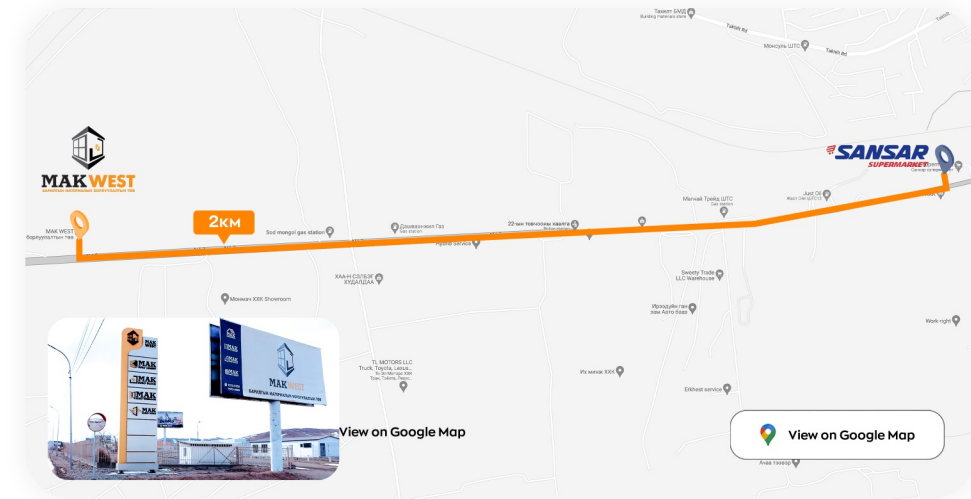

Download
MAKBM app:



MAK Euro Block Plant, Sergelen Soum, Tuv Province
47 km from Ulaanbaatar.

☎ 7575-9700, 9595-0000

✉ makbm@mak.mn

📘 [MAK Euroblock](#)

🌐 makbm.mn